



**afi**

di Mariani & C.  
s.n.c.

apparecchi  
termo  
idraulici

kiwa



SINCERT



# Docce Solari

*Solar Shower*  
*Ducha Solar*  
*Douche Solaire*





**Azienda**

4 stabilimenti produttivi  
 4 soci  
 62 dipendenti  
 76 differenti modelli di scaldacqua  
 1300 clienti  
 15.000 mq di superficie coperta  
 Questi sono i numeri della ATI di Mariani & C. snc, che dal 1973 produce apparecchi ed accessori per il settore del riscaldamento.  
 Processo di produzione certificato ISO 9000.



**Company**

A.T.I. operates from 4 manufacturing plants with a total of 15.000 square meters of covered production area.  
 The company is owned by 4 major shareholders with 62 employees & 1300 major customers.  
 ATI Produces 76 different models of water heater and has been supplying heating industry solutions since 1973 & is ISO 9000 certified.



**Empresa**

4 plantas de manufactura  
 4 socios  
 62 trabajadores  
 76 diferentes modelos de calentadores de agua  
 1300 clientes  
 15.000 mq de superficie cubierta  
 Estos son los números de ATI di Mariani & C. snc, que desde 1973 produce equipos y accesorios para la calefacción.  
 Proceso de producción certificado ISO 9000.



**Société**

4 usines  
 4 associés  
 62 employés  
 76 différents modèles de chauffe-eau  
 1300 clients  
 15.000 mq de surface couverte  
 Celles-ci sont les chiffres d'ATI di Mariani & C. snc, qui produits appareils pour le marché du chauffage depuis 1973.  
 Système de production certifié ISO 9000.



Docce solari professionali ad accumulo, costruite con materiali pregiati:

- gli accessori idraulici quali miscelatore, soffione doccia, ecc. sono in materiali nobili opportunamente trattati
- il design delle docce, di forma circolare, è stato studiato al fine di consentire il posizionamento in ogni direzione assicurando sempre l'assorbimento dei raggi solari a 360°

Professional solar storage showers manufactured with valuable materials:

- the hydraulic accessories such as the water mixer, the shower head, etc. are in noble materials suitably treated
- the design of the showers and their round shape have been specially conceived to allow sun's energy absorption at 360°

Duchas solares de acumulación profesional, construida con materiales de primera calidad:

- los accesorios hidráulicos como mezcladores, ducha ajustable etc. son de materiales nobles adecuadamente tratados
- el diseño de forma circular de las duchas ha sido estudiado a fin de permitir el posicionamiento en cada dirección asegurando siempre la absorción de los rayos solares a 360°

Douche solaire à accumulation professionnelle, produite avec des matériaux nobles:

- les accessoires hydrauliques, tels que le mélangeur, le pommeau de la douche, etc. sont en matériaux de haute qualité opportunément traités
- le design des douches de forme circulaire a été étudié pour permettre la mise en place dans n'importe quelle direction, assurant toujours la captation des rayons solaires à 360°



SOL-S

SOL-M

SOL-N

SOL-C

SOL-P3

SOL-P2



- tubo solare, base d'appoggio e accessori in acciaio inox AISI 316L
- doccia orientabile e regolabile in altezza
- effetto serra grazie ad un tubo in metacrilato

Il design della doccia, di forma circolare, è stato studiato al fine di consentire il posizionamento in ogni direzione assicurando sempre l'assorbimento dei raggi solari a 360°.

Il metacrilato utilizzato è un materiale impiegato nella costruzione dei finestrini degli aerei; il metacrilato rimane inalterato nel tempo mantenendo costante trasparenza e massima captazione dei raggi solari.

Gli accessori idraulici quali miscelatore, soffione doccia, ecc. sono in materiali nobili opportunamente trattati.

Le guarnizioni in gomma sono appositamente studiate per uso esterno del tipo utilizzato nel settore automobilistico.

In una buona giornata d'insolazione e con prelievi ripetuti, la doccia SOL-S può erogare oltre 120 litri di acqua calda sanitaria a temperatura d'utilizzo.



- tubo solar, base de apoyo y todos los accesorios son de acero inoxidable AISI 316L
- ducha ajustable y jabonera
- efecto sierra con tubo de metacrilato

El diseño de forma circular ha sido estudiado a fin de permitir el posicionamiento en cada dirección asegurando siempre la absorción de los rayos solares a 360°.

El metacrilato utilizado es empleado al mismo en la construcción de las ventanillas de los aviones. Dicho material permanece inalterable en el tiempo, manteniendo constante la transparencia y la máxima percepción de los rayos solares.

Los accesorios hidráulicos como mezcladores, ducha deslizante ajustable etc. son de materiales nobles adecuadamente tratados.

Las guarniciones de goma están estudiadas expresamente para su uso externo del mismo tipo utilizado en el sector automovilístico.

En un día bien soleado y con muestreo repetido, la ducha SOL-S puede llegar a producir aproximadamente 120 litros de agua caliente a una temperatura de utilizzo.



- solar pipe, basement and all the accessories made of AISI 316L stainless steel
- adjustable shower
- greenhouse effect achieved thanks to a methacrylate tube

The design of the shower and its round shape have been specially conceived to allow sun's energy absorption at 360°.

Methacrylate used for the greenhouse effect is the same material used for plane windows, and it keeps constantly transparent in the time granting the best efficiency in solar energy absorption.

The hydraulic accessories such as the water mixer, the shower head, etc. are in noble materials suitably treated.

The rubber seals, that are made of the same material used in the car industry, have been specially conceived for use in outer spaces.

In sunny days, even when water is frequently used, the shower SOL-S can give more than 120 litres of domestic hot water at use temperature.



- tube solaire, base d'appui et tous les accessoires en acier inoxydable AISI 316L
- douche réglable aussi en hauteur
- effet de serre par un tube en méthacrylate

Le design de la douche, de forme circulaire, a été étudié pour en permettre la mise en place dans n'importe quelle direction, assurant toujours la captation des rayons solaires à 360°.

Le méthacrylate, matériel employé aussi pour la production des vitres des avions, garde une transparence constante dans le temps et, par conséquent, une haute captation des rayons solaires. Les accessoires hydrauliques, tels que le mélangeur, le pommeau de la douche, etc. sont en matériaux de haute qualité opportunément traités.

Les joints en silicone, du même type employé dans le secteur automobile, ont été spécialement conçus pour usage externe.

En période de soleil abondant, même avec soutirages fréquents, le débit d'eau chaude sanitaire à température d'utilisation de la douche SOL-S est d'environ 120 litres.



**CARATTERISTICHE / SPECIFICATION**  
**CARACTERISTICAS / CARACTÉRISTIQUES**

Capacità serbatoio Tank capacity Volumen tubo Volume ballon	28 lt
Attacchi acqua Water connection Conexiones agua Reccordements eau	1/2"
Pressione massima Maximum pressure Presión máxima Pression maximum	5 bar
Taratura valvola di sicurezza Safety valve calibration Calibración válvula de seguridad Tarage soupape de sécurité	6 bar
Area minima di captazione Minimum absorption area Area minima de captation Surface minimum d'absorption	0,88 m <sup>2</sup>
Trasmittanza metacrilato Transmittance of methacrylate Transmission luminosa metacrilato Transfert lumineux du methacrylate	92,2 %
Peso a vuoto Net weight Peso neto Poids net	13 Kg

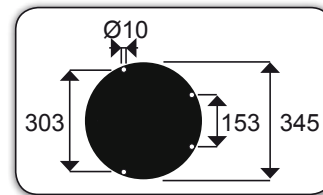
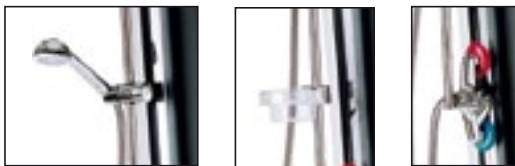
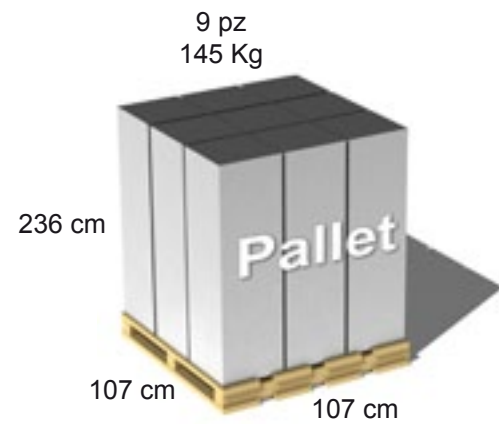
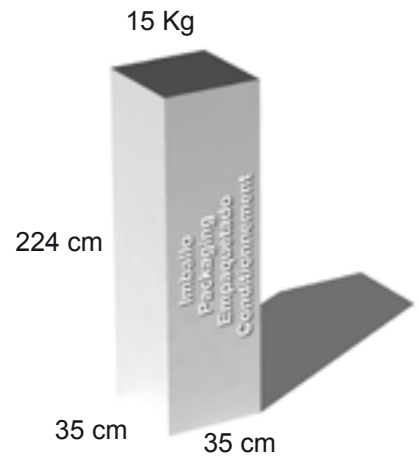
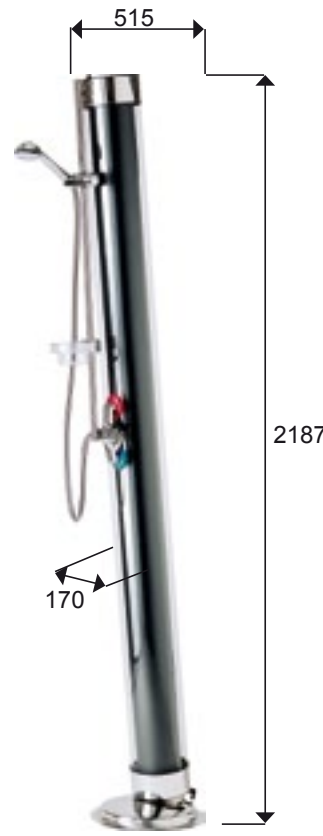



- tubo solare in acciaio vetroporcellanato
- base d'appoggio in acciaio zincato sp. 4 mm
- anodo al magnesio
- effetto serra grazie ad un tubo in metacrilato

Il design della doccia, di forma circolare, è stato studiato al fine di consentire il posizionamento in ogni direzione assicurando sempre l'assorbimento dei raggi solari a 360°. Il metacrilato utilizzato è un materiale impiegato nella costruzione dei finestrini degli aerei; questo rimane inalterato nel tempo mantenendo costante trasparenza e massima captazione dei raggi solari. Gli accessori idraulici quali miscelatore, soffione doccia, ecc. sono in materiali nobili opportunamente trattati. Le guarnizioni in gomma sono appositamente studiate per uso esterno del tipo utilizzato nel settore automobilistico. In una buona giornata d'insolazione e con prelievi ripetuti, la doccia SOL-M può erogare fino a 240 litri di acqua calda sanitaria a temperatura d'utilizzo.

**È ideale per campeggi, agriturismi, villaggi turistici e per uso collettivo.**



- tubo solar de acero porcelanado
- base de apoyo de acero cincado sp. 4 mm
- ánodo de magnesio
- efecto sierra con tubo de metacrilato

El diseño de forma circular ha sido estudiado a fin de permitir el posicionamiento en cada dirección asegurando siempre la absorción de los rayos solares a 360°. El metacrilato utilizado es el mismo empleado en la construcción de las ventanillas de los aviones; dicho material permanece inalterable en el tiempo, manteniendo constante la transparencia y la máxima percepción de los rayos solares. Los accesorios hidráulicos como mezcladores, ducha etc. son de materiales nobles adecuadamente tratados. Las guarniciones de goma están estudiadas expresamente para su uso externo del mismo tipo utilizado en el sector automovilístico. En un día bien soleado y con muestreo repetido, la ducha SOL-M puede llegar a producir hasta 240 litros a una temperatura de utilizzo.

**Es ideal para camping, villas turísticas y para uso colectivo.**



- solar tube of the Maxi shower in enamelled steel
- basement in 4 mm thick galvanised steel
- magnesium anode
- greenhouse effect achieved thanks to a methacrylate tube

The design of the shower and its round shape have been specially conceived to allow sun's energy absorption at 360°. Methacrylate used for the greenhouse effect is the same material used for plane windows, and it keeps constantly transparent in the time granting the best efficiency in solar energy absorption. The hydraulic accessories such as the water mixer, the shower head, etc. are in noble materials suitably treated. The rubber seals, that are made of the same material used in the car industry, have been specially conceived for use in outer spaces. In sunny days, even when water is frequently used, the shower SOL-M can give till 240 litres of domestic hot water at use temperature.

**It is suitable for camping sites, holiday villages and collective use.**



- tube solaire en acier émaillé
- base d'appui en acier galvanisé épaisseur de 4 mm
- anode en magnésium
- effet de serre par un tube en méthacrylate

Le design de la douche, de forme circulaire, a été étudié pour en permettre la mise en place dans n'importe quelle direction, assurant toujours la captation des rayons solaires à 360°. Le méthacrylate, matériel employé aussi pour la production des vitres des avions, garde une transparence constante dans le temps et, par conséquent, une haute captation des rayons solaires. Les accessoires hydrauliques, tels que le mélangeur, le pommeau de la douche, etc. sont en matériaux de haute qualité opportunément traités. Les joints en silicone, du même type employé dans le secteur automobile, ont été spécialement conçus pour usage externe. En période de soleil abondant, même avec soutirages fréquents, le débit d'eau chaude sanitaire à température d'utilisation de la douche SOL-S est d'environ 120 litres.

**C'est idéal pour les terrains de camping, villages touristiques et pour une utilisation collective.**



**CARATTERISTICHE / SPECIFICATION**  
**CARACTERISTICAS / CARACTÉRISTIQUES**

Capacità serbatoio Tank capacity Volumen tubo Volume ballon	<b>120 lt</b>
Attacchi acqua Water connection Conexiones agua Reccordements eau	3/4"
Pressione massima Maximum pressure Presión máxima Pression maximum	5 bar
Taratura valvola di sicurezza Safety valve calibration Calibración válvula de seguridad Tarage soupape de sécurité	6 bar
Area minima di captazione Minimum absorption area Area minima de captation Surface minimum d'absorption	1,83 m <sup>2</sup>
Trasmittanza metacrilato Transmittance of methacrylate Transmision luminosa metacrilato Transfert lumineux du methacrylate	92,2 %
Peso a vuoto Net weight Peso neto Poids net	55 Kg

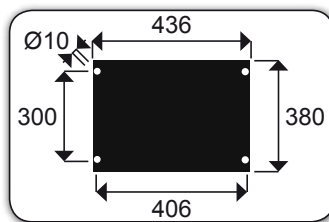
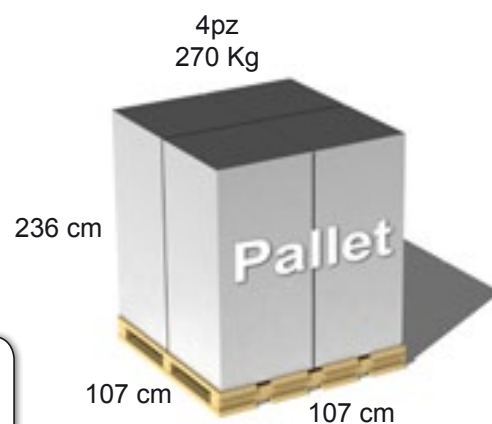
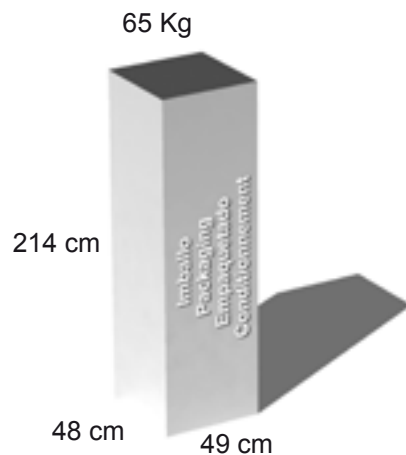



- tubo solare, base d'appoggio e accessori in acciaio inox AISI 316L
- effetto serra grazie ad un tubo in metacrilato

Il design della doccia, di forma circolare, è stato studiato al fine di consentire il posizionamento in ogni direzione assicurando sempre l'assorbimento dei raggi solari a 360°.

Il metacrilato utilizzato è un materiale impiegato nella costruzione dei finestrini degli aerei; il metacrilato rimane inalterato nel tempo mantenendo costante trasparenza e massima captazione dei raggi solari.

Gli accessori idraulici quali miscelatore, soffione doccia, ecc. sono in materiali nobili opportunamente trattati.

Le guarnizioni in gomma sono appositamente studiate per uso esterno del tipo utilizzato nel settore automobilistico.

In una buona giornata d'insolazione e con prelievi ripetuti, la doccia SOL-N può erogare oltre 120 litri di acqua calda sanitaria a temperatura d'utilizzo.



- tubo solar, base de apoyo y todos los accesorios son de acero inoxidable AISI 316L
- efecto sierra con tubo de metacrilato

El diseño de forma circular de la ducha ha sido estudiado a fin de consentir el posicionamiento en cada dirección asegurando siempre la absorción de los rayos solares a 360°.

Metacrilato utilizado es empleado en la construcción de las ventanillas de los aviones; dicho material permanece inalterable en el tiempo, manteniendo constante la transparencia y la máxima percepción de los rayos solares.

Los accesorios hidráulicos como mezcladores, ducha etc. son de materiales nobles oportunamente tratados.

La guarnición de goma está estudiada expresamente para el uso externo del tipo utilizado en el sector automovilístico.

En un día bien soleado y con muestreo repetido, la ducha SOL-N pueden llegar a producir aproximadamente 120 litros de agua caliente a una temperatura de utilizo.



- solar pipe, basement and all the accessories made of AISI 316L stainless steel
- greenhouse effect achieved thanks to a methacrylate tube

The design of the shower and its round shape have been specially conceived to allow sun's energy absorption at 360°.

Methacrylate used for the greenhouse effect is the same material used for plane windows, and it keeps constantly transparent in the time granting the best efficiency in solar energy absorption.

The hydraulic accessories such as the water mixer, the shower head, etc. are in noble materials suitably treated.

The rubber seals, that are made of the same material used in the car industry, have been specially conceived for use in outer spaces.

In sunny days, even when water is frequently used, the shower SOL-N can give more than 120 litres of domestic hot water at use temperature.



- tube solaire, base d'appui et tous les accessoires en acier inoxydable AISI 316L
- effet de serre par un tube en méthacrylate

Le design de la douche, de forme circulaire, a été étudié pour en permettre la mise en place dans n'importe quelle direction, assurant toujours la captation des rayons solaires à 360°.

Le méthacrylate, matériel employé aussi pour la production des vitres des avions, garde une transparence constante dans le temps et, par conséquent, une haute captation des rayons solaires. Les accessoires hydrauliques, tels que le mélangeur, le pommeau de la douche, etc. sont en matériaux de haute qualité opportunément traités.

Les joints en silicone, du même type employé dans le secteur automobile, ont été spécialement conçus pour usage externe.

En période de soleil abondant, même avec soutirages fréquents, le débit d'eau chaude sanitaire à température d'utilisation de la douche SOL-S est d'environ 120 litres.



**CARATTERISTICHE / SPECIFICATION**  
**CARACTERISTICAS / CARACTÉRISTIQUES**

Capacità serbatoio Tank capacity Volumen tubo Volume ballon	28 lt
Attacchi acqua Water connection Conexiones agua Reccordements eau	1/2"
Pressione massima Maximum pressure Presión máxima Pression maximum	5 bar
Taratura valvola di sicurezza Safety valve calibration Calibración válvula de seguridad Tarage soupape de sécurité	6 bar
Area minima di captazione Minimum absorption area Area minima de captation Surface minimum d'absorption	0,88 m <sup>2</sup>
Trasmittanza metacrilato Transmittance of methacrylate Transmision luminosa metacrilato Transfert lumineux du methacrylate	92,2 %
Peso a vuoto Net weight Peso neto Poids net	10 Kg

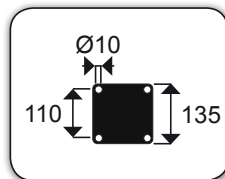
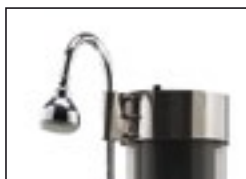
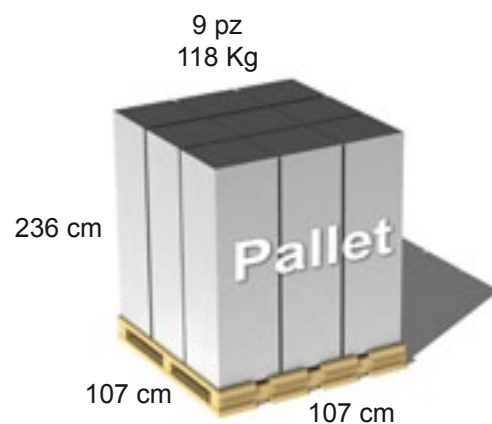
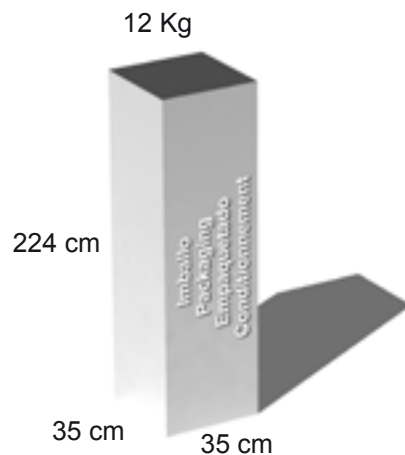
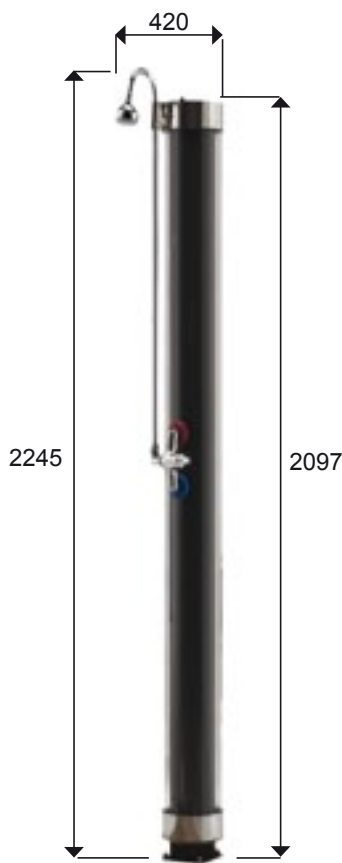



Doccia solare di forma circolare, di design appositamente studiato per consentire il posizionamento in ogni direzione assicurando sempre l'assorbimento dei raggi solari a 360°.

Principali componenti :

- serbatoio in acciaio inox AISI 316 L
- parti idrauliche (miscelatore, soffione doccia, rubinetto) in materiali nobili opportunamente trattati
- guarnizioni appositamente studiate per uso esterno



Solar Shower of circular shape, specifically designed to allow placement in every direction, always ensuring the absorption of sunlight at 360°.

Main components:

- tank stainless steel AISI 316 L
- hydraulic parts (mixer, shower head, faucet) in noble materials properly treated
- rubber seals specifically designed for outdoor use



Ducha solar de diseño circular, diseñado específicamente para permitir la colocación en todas las direcciones, siempre velando por la absorción de la luz solar a 360°.

Principales componentes:

- tanque en acero inoxidable 316 L
- los accesorios hidráulicos (mezclador, ducha, grifo) en materiales nobles se trata adecuadamente
- guarnición diseñadas específicamente para el uso externo



Douche solaire de forme circulaire, spécialement conçu pour permettre le placement dans tous les sens, toujours veiller à l'absorption de la lumière du soleil à 360°.

Principaux composants:

- cuve en acier inox AISI 316 L
- pièces hydrauliques (mixer, tête de douche, robinet) dans des matières nobles correctement traités
- joints en silicone spécialement conçu pour une utilisation en extérieur



**CARATTERISTICHE / SPECIFICATION**  
**CARACTERISTICAS / CARACTÉRISTIQUES**

Capacità serbatoio Tank capacity Volumen tubo Volume ballon	28 lt
Attacchi acqua Water connection Conexiones agua Reccordements eau	1/2"
Pressione massima Maximum pressure Presión máxima Pression maximum	5 bar
Peso a vuoto Net weight Peso neto Poids net	5 Kg

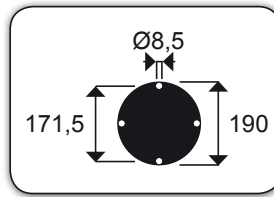
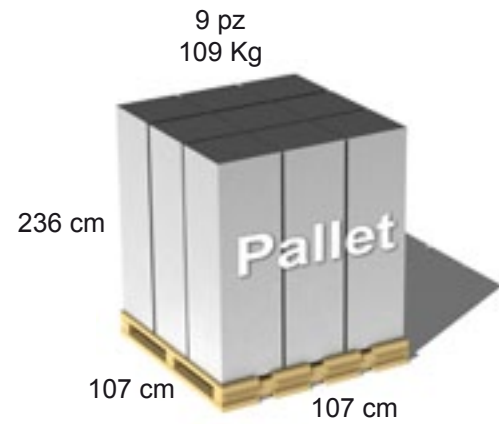
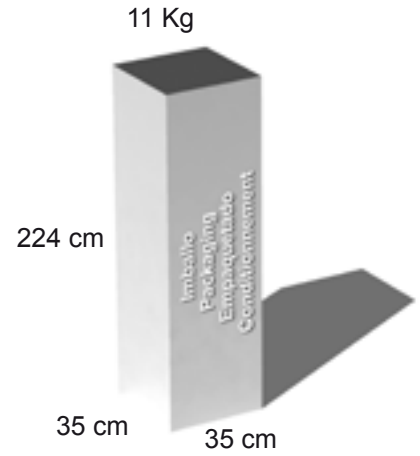



- tubo solare in polipropilene atossico adatto per usi alimentari e stabilizzato UV
- base in acciaio inox AISI 304

Il design della doccia, di forma circolare, è stato studiato al fine di consentire il posizionamento in ogni direzione assicurando sempre l'assorbimento dei raggi solari a 360°. Gli accessori idraulici quali miscelatore, soffione doccia, ecc. sono in materiali nobili opportunamente trattati. Le guarnizioni in gomma sono appositamente studiate per uso esterno del tipo utilizzato nel settore automobilistico. In una buona giornata d'insolazione e con prelievi ripetuti, la doccia SOL-P3 può erogare circa 50 litri di acqua calda sanitaria a temperatura d'utilizzo.



- shower tank material made of non-toxic polypropylene suitable for food uses and UV-stable
- basement in AISI 304 stainless steel

The design of the shower and its round shape have been specially conceived to allow sun's energy absorption at 360°. The hydraulic accessories such as the water mixer, the shower head, etc. are in noble materials suitably treated. The rubber seals, that are made of the same material used in the car industry, have been specially conceived for use in outer spaces. In sunny days, even when water is frequently used, the shower SOL-P3 can give about 50 litres of domestic hot water at use temperature.



- tubo solar de polipropileno no tóxico apto para alimentos y estabilizados "UV"
- base de apoyo de acero inoxidable AISI 304

El diseño de forma circular de la ducha ha sido estudiado a fin de consentir el posicionamiento en cada dirección asegurando siempre la absorción de los rayos solares a 360°. Los accesorios hidráulicos como mezcladores, ducha etc. son de materiales nobles oportunamente tratados. La guarnición de goma está estudiada expresamente para el uso externo del tipo utilizado en el sector automovilístico. En un día bien soleado y con muestreo repetido, la ducha SOL-P3 pueden llegar a producir aproximadamente 50 litros de agua caliente a una temperatura de utilizo.



- tube solaire en polypropylène atoxique apte pour usages alimentaires et stabilisé aux UV
- base d'appui en acier inoxydable AISI 304

Le design de forme circulaire de la douche a été étudié pour en permettre la mise en place dans n'importe quelle direction, assurant toujours la captation des rayons solaires à 360°. Les accessoires hydrauliques, tels que le mélangeur, le pommeau de la douche, etc. sont en matériaux de haute qualité opportunément traités. Les joints en silicone, du même type employé dans le secteur automobile, ont été spécialement conçus pour usage externe. En période de soleil abondant, même avec soutirages fréquents, le débit d'eau chaude sanitaire à température d'utilisation de la douche SOL-P3 est d'environ 50 litres.



**CARATTERISTICHE / SPECIFICATION**  
**CARACTERISTICAS / CARACTÉRISTIQUES**

Capacità serbatoio Tank capacity Volumen tubo Volume ballon	38 lt
Attacchi acqua Water connection Conexiones agua Reccordements eau	1/2"
Pressione massima Maximum pressure Presión máxima Pression maximum	3 bar
Peso a vuoto Net weight Peso neto Poids net	8 Kg

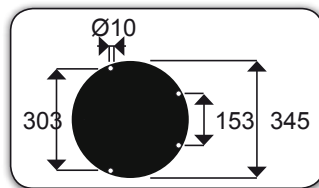
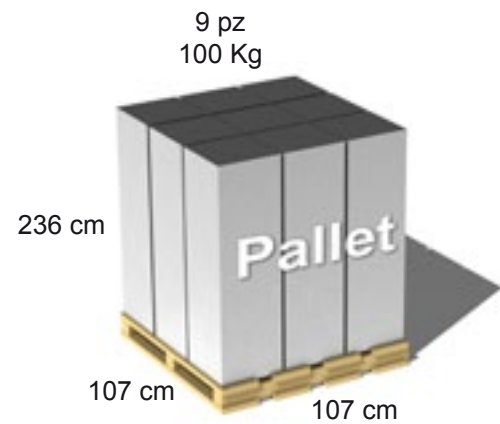
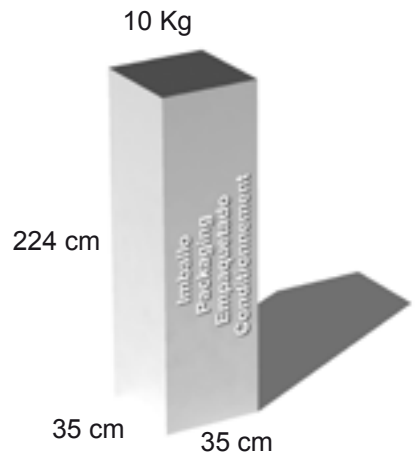



Doccia solare di forma circolare, di design appositamente studiato per consentire il posizionamento in ogni direzione assicurando sempre l'assorbimento dei raggi solari a 360°.

Principali componenti :

- serbatoio in polipropilene atossico adatto per usi alimentari e stabilizzato UV
- base in acciaio inox AISI 304
- parti idrauliche (miscelatore, soffione doccia, rubinetto) in materiali nobili opportunamente trattati
- guarnizioni appositamente studiate per uso esterno



Round solar shower with a design that has been specially conceived to allow sun's energy absorption at 360°.

Main features:

- shower tank made of non-toxic and UV-stable polypropylene suitable for food uses
- basement in AISI 304 stainless steel
- hydraulic accessories (water mixer, shower head, tap) in noble materials suitably treated
- rubber seals suitable for usage in outer spaces



Ducha solar de forma circular, estudiada a fin de permitir el posicionamiento en cada dirección asegurando siempre la absorción de los rayos solares a 360°.

Partes principales:

- tubo solar de polipropileno no tóxico apto para alimentos y estabilizado «UV»
- base de apoyo de acero inoxidable AISI 304
- accesorios hidráulicos (mezcladores, ducha y grifo) de materiales nobles oportunamente tratados
- guarnición estudiada expresamente para el uso externo



Douche solaire de forme circulaire, ayant un design qui a été étudié pour en permettre la mise en place dans n'importe quelle direction, assurant toujours la captation des rayons à 360°.

Parties principales:

- cuve en polypropylène non toxique stabilisé aux UV et apte aux usages alimentaires
- base d'appui en acier inoxydable AISI 304
- accessoires hydrauliques (mélangeur, pommeau de la douche et robinet) en matériaux de haute qualité opportunément traités
- joints spécialement conçus pour usage externe



**CARATTERISTICHE / SPECIFICATION**  
**CARACTERISTICAS / CARACTÉRISTIQUES**

Capacità serbatoio Tank capacity Volumen tubo Volume ballon	23 lt
Attacchi acqua Water connection Conexiones agua Reccordements eau	1/2"
Pressione massima Maximum pressure Presión máxima Pression maximum	3 bar
Peso a vuoto Net weight Peso neto Poids net	5,5 Kg

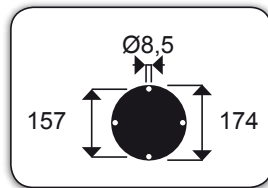
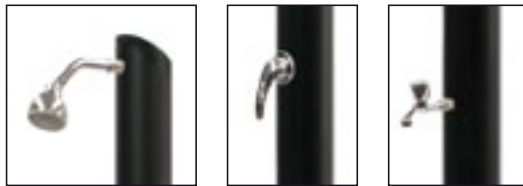
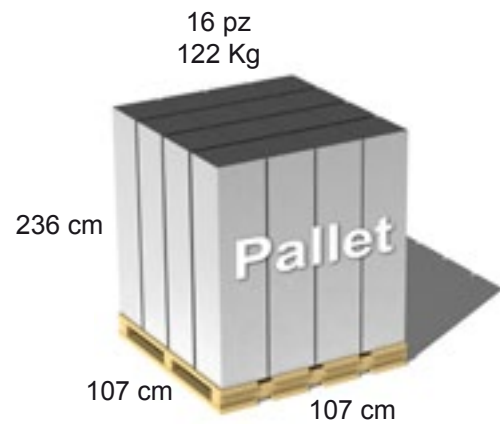
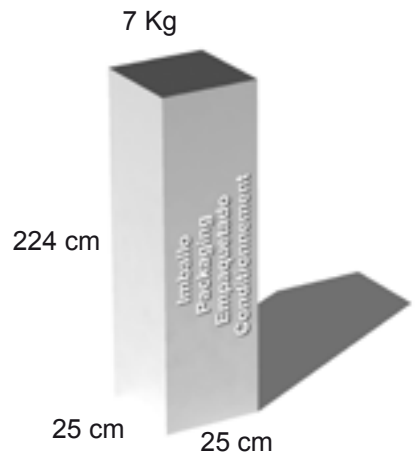

		SOL-S	SOL-N	SOL-C	SOL-M	SOL-P3	SOL-P2
Altezza corpo doccia Body shower - vertical height Estatura ducha Hauteur douche	mm	2187	2156	2155	2177	2156	2187
Ingombro orizzontale Basement Base Base	mm	515x345	135x135	190x190	380x436	345x345	135x135
Capacità serbatoio Tank capacity Volumen tubo Volume ballon	lt	28	28	28	120	38	23
Attacchi acqua Water connection Conexiones agua Reccordements eau	"	1/2	1/2	1/2	3/4	1/2	1/2
Pressione massima Maximum pressure Presión máxima Pression maximum	bar	5	5	5	5	3	3
Valvola di sicurezza Safety valve Válvula de seguridad Soupape de sécurité		X	X		X		
Serbatoio Tank Tanque Reservoir		inox AISI 316L AISI 316L stainless steel acero inox. AISI 316L acier inoxydable AISI 316L			acc.smaltato enamelled steel acero esmaltado acier émaillé	polipropilene polypropylene polipropileno polypropylène	
Doccia regol. in altezza Height-adjustable shower head Ducha deslizando en excelsitud Douche réglable en hauteur		X					
Doccia orientabile Adjustable shower head Ducha orientable Douche orientable		X	X	X	X	X	X
Miscelatore Water mixer Mezclador Robinet mélangeur		X	X	X	X	X	X
Portasapone Soap dish Jabonera Porte-savon		X					
Trasmittanza metacrilato Transmittance of methacrylate Transmission luminosa metacrilato Transfert lumineux du methacrylate	%	92,2	92,2	-	92,2	-	-
Peso a vuoto Net weight Peso neto Poids net	Kg	13	10	5	55	8	5,5
Dimensioni e peso imballo Packaging dimensions and weight Dimension y peso empaquetado Dimensions et poids emballage	cm	224x35x35	224x35x35	224x35x35	214x48x49	224x35x35	225x25x25
	Kg	15	12	11	65	10	7
Q.tà x pallet cm 105x105 Pcs on pallet cm 105x105 Unid. x pallet cm 105x105 Pièces sur palette cm 105x105		9	9	9	4	9	16

Cod. / Ref.	Descrizione / Description	SOL-S	SOL-N	SOL-C	SOL-M	SOL-P3	SOL-P2
<b>SOLPED</b>	pedana in legno teak 80x120 cm teak wood basement 80x120 cm	X	X	X	X	X	X
<b>A.130-0159</b>	soffione largo Ø150 maxi shower head Ø150	X	X	X	X		
<b>A.705</b>	puntazza per fissaggio tip for fixing		X	X			X



Pedana in legno teak 80x120 cm (SOLPED)  
Teak wood basement 80x120 cm (SOLPED)



Soffione largo Ø150 (A.130-0159)  
Maxi shower head Ø150 (A.130.0159)



Puntazza per fissaggio (A.705)  
Tip for fixing (A.705)

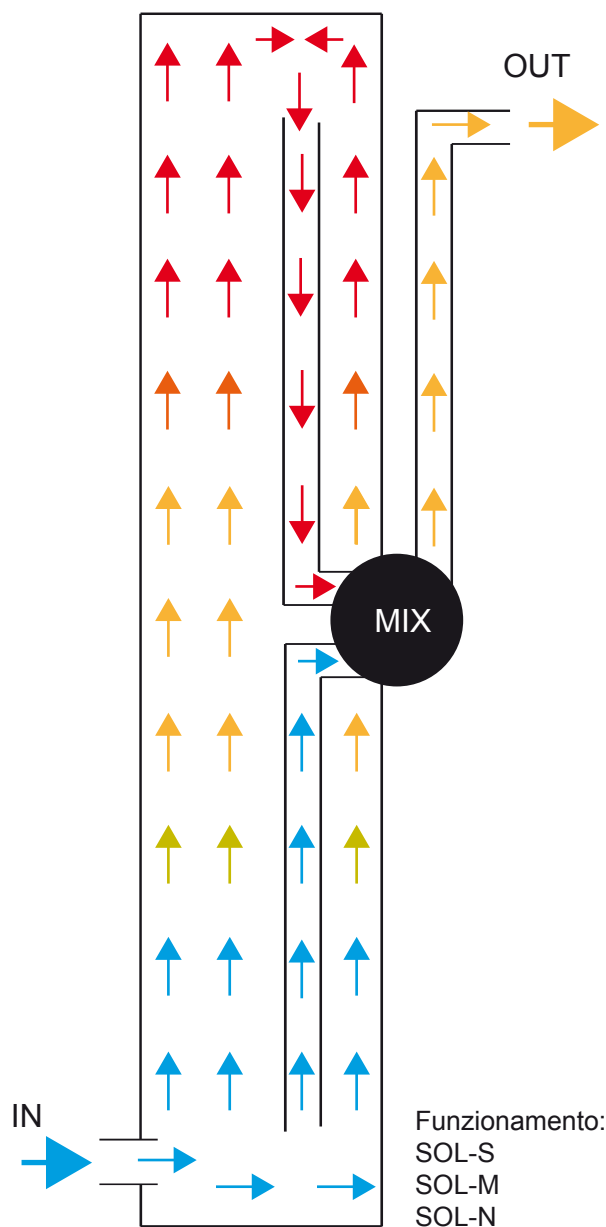
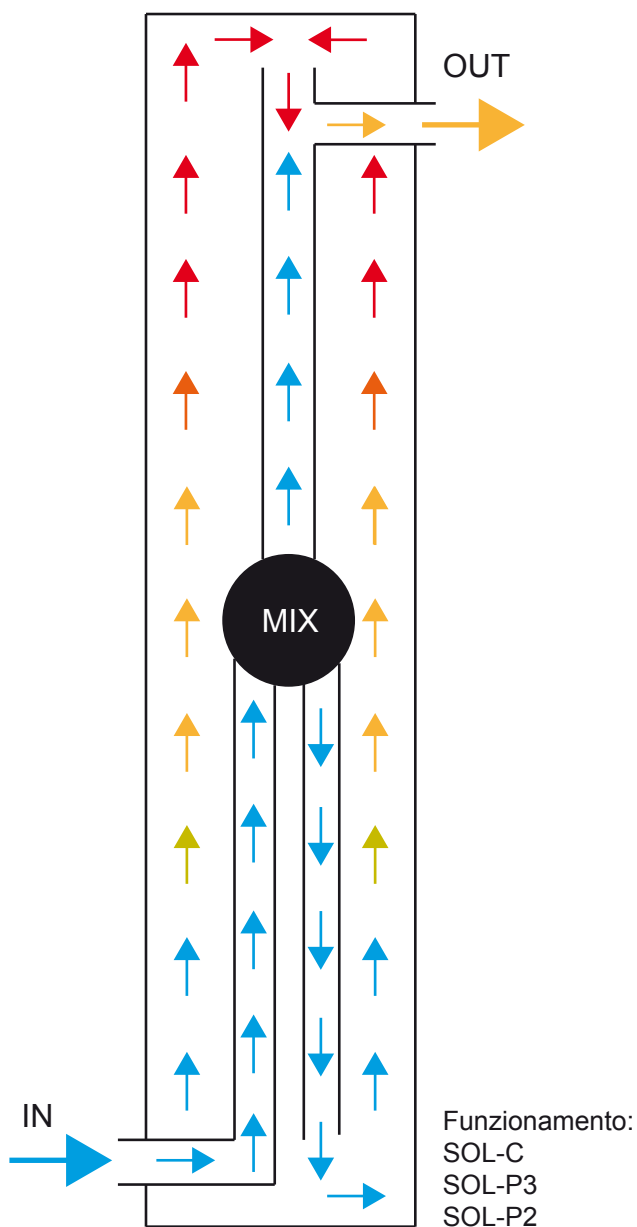



### Docce per Esterno

ATI offre anche un'ampia gamma di docce per esterno (non solari) in acciaio inox AISI 316.

Per maggiori informazioni richiedi il catalogo specifico!



### Outdoor Shower

ATI offers also a wide range of showers in AISI 316 stainless steel for Outdoors.

For more information about this range, ask for its specific catalogue!



### Duchas Para Exterior

ATI ofrece también una amplia gama de duchas (no solar) para exteriores en acero inoxidable AISI 316.

Para obtener más información, pida su catálogo específico.



### Douches D'extérieur

ATI offre aussi une vaste gamme de douches d'extérieur (non solaires) en acier inoxydable AISI 316.

Pour tout renseignement, demandez la brochure spécifique de cette gamme.

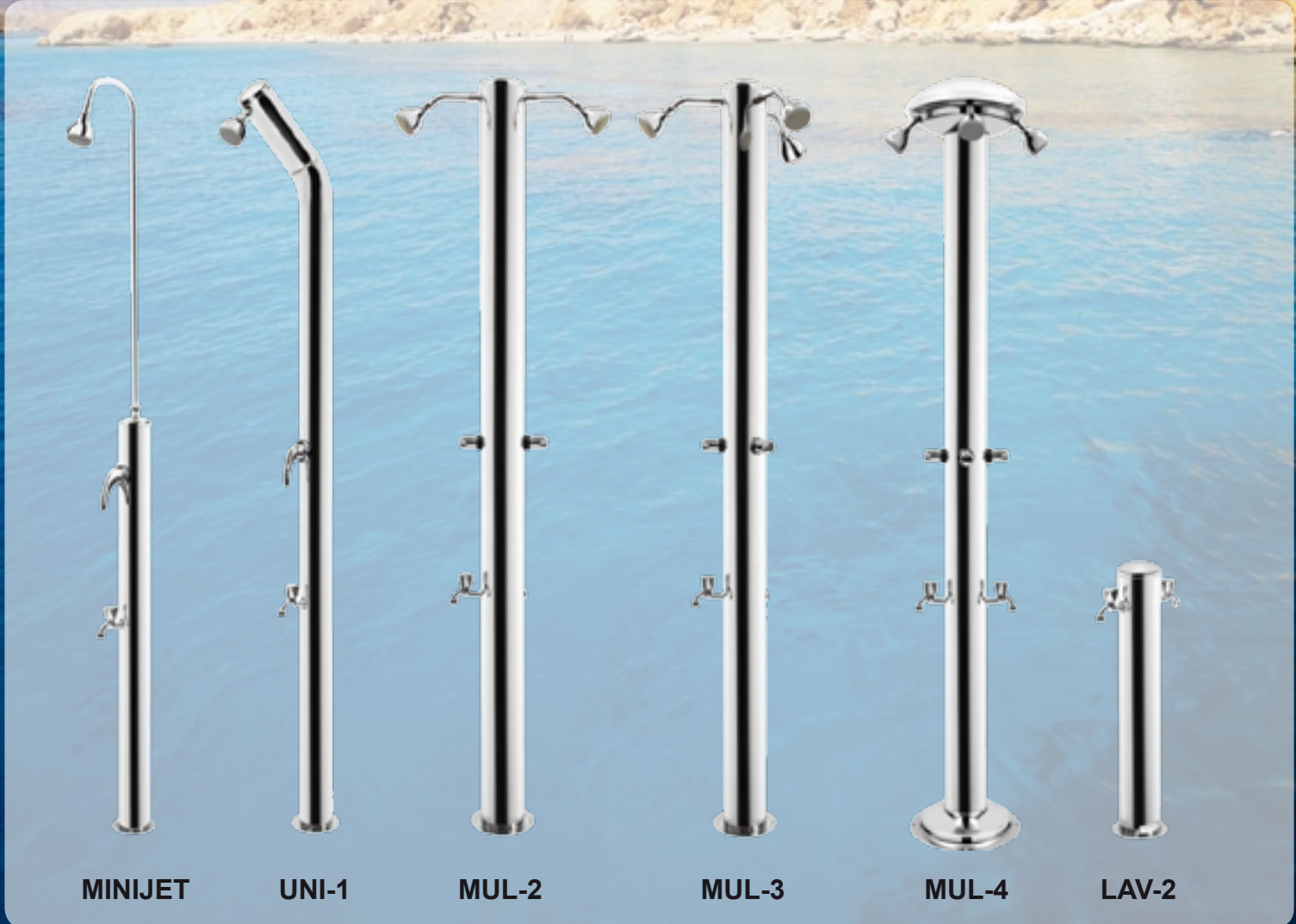



### Processo Produttivo

- scelta materiali di qualità certificata
- saldatura conforme a EN 297
- collaudo a pressione del 100% della produzione
- smaltatura con materiale certificato DIN 4753 e BS 6920 (si veda gamma vetroporcellanata)



### Manufacturing Process

- qualified choosing of materials
- welding process complying EN 297
- pressure testing (100% of production)
- enamelling with certified material DIN 4753 and BS 6920 (ref. enamelled range)



### Sistema de producción

- elección de materiales de calidad
- soldadura en conformidad de la norma EN 297
- prueba en presión de el 100% de la producción
- tratamiento de vidrio-porcelanado con material certificado DIN 4753 y BS 6920 (ref. gama esmaltada)



### Système de production

- choix de matériaux de qualité certifiée
- soudure en conformité de la norme EN 297
- essai à pression du 100% de la production
- émaillage avec matériel certifié DIN 4753 et BS 6920 (voir gamme émaillée)

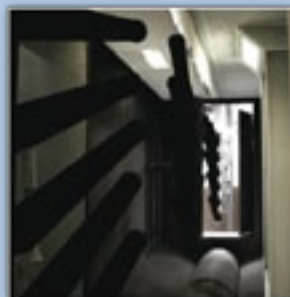
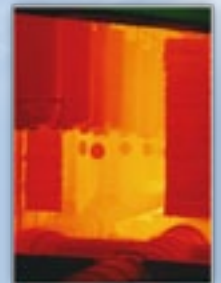



**di Mariani & C.**  
s.n.c.

apparecchi  
termo  
idraulici



## **A.T.I. di Mariani & C. s.n.c.**

Via E. Mattei, 461  
zona Industriale n° 4 Torre del Moro  
47522 Cesena (FC) - Italia

Tel.: +39 0547 609711  
Fax: +39 0547 609724  
Web: [docce.atimariani.it](http://docce.atimariani.it)  
Email: [docce@atimariani.it](mailto:docce@atimariani.it)

Coordinate GPS 44°9'34.79"N 12°12'42.19"E



**<< QRCode per Smartphones!**  
È un codice 2D leggibile anche dagli smartphone che contiene informazioni: in questo caso il link al nostro sito! Per informazioni sui QRCode visita [www.atimariani.it/qrcode.php](http://www.atimariani.it/qrcode.php)



Il costruttore non assume responsabilità per eventuali errori o inesattezze sul contenuto del presente listino, si riserva il diritto di apportare ai suoi prodotti, in qualunque momento e senza preavviso, modifiche ritenute opportune per migliorie tecniche o esigenze commerciali, nel costante perseguimento del miglioramento della qualità. Disegni e foto relativi ai prodotti non sono contrattuali.

Timbro Rivenditore